

Evolution UV-Vis Spectrophotometers

Reliable, versatile UV-Vis solutions to get your answers fast

Meet today's demands head-on with a solution-based approach

Our next generation Thermo Scientific™ Evolution™ UV-Vis Spectrophotometers combine reliable and versatile hardware with easy-to-learn, easy-to-use Thermo Scientific™ Insight™ Pro Software. Together they will meet the diverse needs your organization requires from an analytical tool.

Reliable, versatile hardware

- Address your laboratory's requirements with fixed or variable bandwidth options
- Meet chemical, materials science, or biological sampling and measurement needs requirement with a broad range of accessories
- All accessories from previous Evolution UV-Vis Spectrophotometer models are compatible with today's Evolution Spectrophotometers

A software partner

- Supports current 21 CFR Part 11 compliance, including database storage
- Validate according to current USP, EP, or JP standards
- Streamline your routine, complex and advanced routines and workflows

Evolution One UV-Vis Spectrophotometer

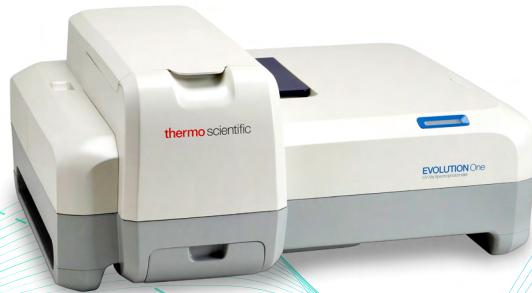

Evolution One Plus UV-Vis Spectrophotometer



Evolution Pro UV-Vis Spectrophotometer



Life Science

Materials Science

Food & Beverage

Academic

Pharmaceuticals

Chemicals

Environmental

Industrial QA/QC

Easy to learn, easy to use

Make your lab time more productive with Insight Pro Software

Reduce training time

Optimized user interface with prompting software. Define clear step-by-step workflows that are easy to teach, learn, and use.

Prevent costly sampling and measurement errors

Create dedicated workflows for complex assays and transform multi-step workflows into one simplified, easy-to-follow method suitable for any user level with Customized User Environment (CUE).

Always current

Whether it is user inputs, application requirements, or new regulations, Insight Pro Software is continuously improving with quick upgrades to deliver greater capabilities and efficiencies for your lab's needs.

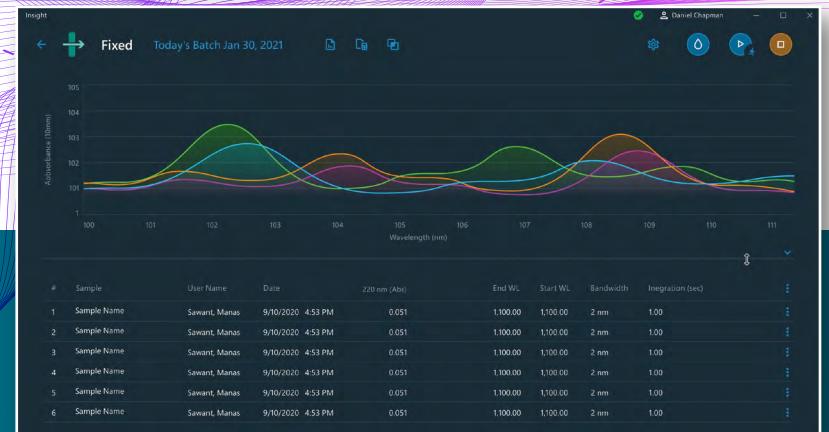
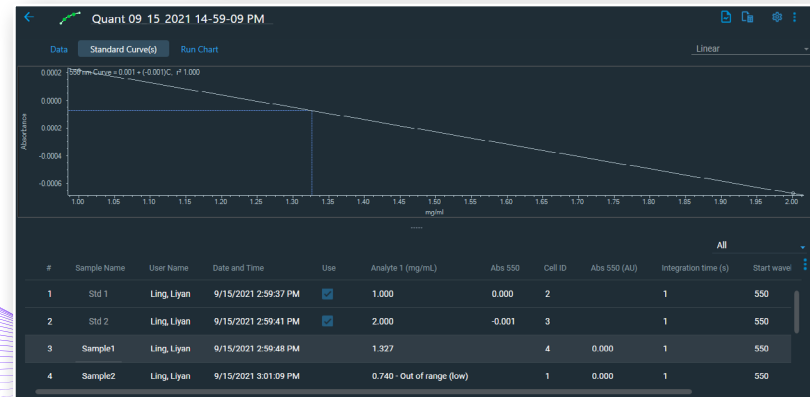
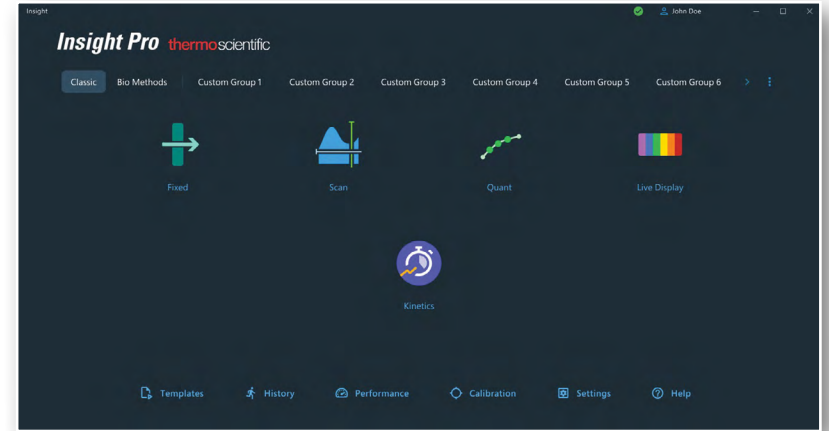

Approach current regulatory compliance with confidence

Integrity of your scientific data is assured with Thermo Scientific™ Insight™ Pro Security Software

Insight Pro Security Software helps your lab stay compliant. It includes all of the benefits of Insight Pro Software with added security for ensuring integrity of scientific data required by pharmaceutical, biotech companies and academics working on FDA regulated studies.

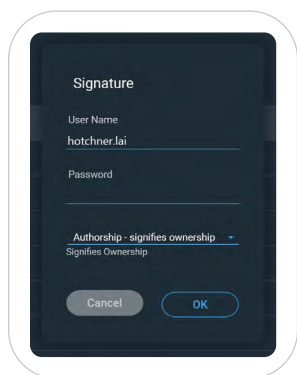

Assists with US FDA 21 CFR Part 11 compliance

- Control user account access, apply digital signatures, implement controls, view electronic audit trails for reliable electronic documentation
- Database storage ensures electronic records are properly maintained for FDA submissions

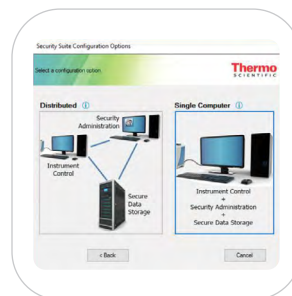

Option to network single or multiple instruments

- Install Insight Pro Security Software on a central computer to control privileges
- Log across multiple Evolution UV-Vis instruments in different labs



Establish wavelength accuracy without re-certifying standard solutions or calibration

- A pre-installed mercury lamp option is available for the Evolution Pro.
- Stand-alone mercury lamp accessories are also available for the Evolution Pro and Evolution One/One Plus instruments.

Streamline installation qualification (IQ) and operational qualification (OQ)

Take the guess work out of your system validation routine

Insight Pro Software provides support for system qualification and validation activities for instruments, software and accessories.

Supports current 2019 USP, EP, and JP requirements*

- Validate your system—Insight Pro Software includes methods to run IQ/OQ verification testing:
 - Evaluate instrument performance within manufacturer’s specifications
 - Satisfy current pharmacopoeia requirements

Learn more about validated systems at
[thermofisher.com/evvalidatedsystems](https://www.thermofisher.com/evvalidatedsystems)

*To complete your validation, a full range of qualification filter and pharmacopoeia standards kits are available:

- For general instrument qualification: Qualification Filter Kit for UV-Vis contains some of the standards used for pharmacopoeia PV testing
- USP and EP standard sets available to meet all pharmacopoeia requirements for qualification in the UV as well as visible regions



Choose the instrument that's right for you

EVOLUTION One UV-Vis Spectrophotometer

Routine measurements, high-resolution data

- 1.0 nm fixed spectral bandwidth for focused quality control applications
- Long-term stability during data acquisition with double-beam optics
- Create clear, simplified workflows for repeatable results that are easy-to-train and easy-to-learn
- Easy access to your samples with large, room light resistant sample compartment

EVOLUTION One Plus UV-Vis Spectrophotometer

Greater experimental flexibility for research and more complex applications

- Selectable 1 and 2 nm spectral bandwidth for enhanced photometric performance
- Long-term stability during data acquisition with double-beam optics
- Applications focused beam geometry to optimize photometric performance with microcells, fiber optics, and materials accessories
- Accessory options for most challenging samples including integrating sphere for transmittance and reflectance of scattering materials

EVOLUTION Pro UV-Vis Spectrophotometer

Comprehensive solution for advanced applications

- Optimize performance for advanced testing and peak resolution requirements with selectable bandwidths of 0.5, 1.0, 1.5, 2.0 and 4.0 nm
- Long-term stability during data acquisition with double-beam optics and a reference position detector for monitoring control samples
- Increased flexibility with extra-large, room light resistant sample compartment and parallel beam design for advanced high-throughput applications



	Evolution One UV-Vis Spectrophotometer	Evolution One Plus UV-Vis Spectrophotometer	Evolution Pro UV-Vis Spectrophotometer
Application	Routine QC applications	Research and complex applications	High-value QA/QC, advanced research
Hardware			
Spectral Bandwidth	Fixed: 1 nm	Variable: 1 nm, 2 nm AFBG Microcell optimized; AFBG Fiber optic optimized; AFBG Materials optimized	Variable: 0.5, 1, 1.5, 2, 4 nm
Light Source	Xenon flash lamp	Xenon flash lamp	Xenon flash lamp
Optical System	Double beam	Double beam	Double beam
Featured accessories	Single and multi-cell holders, Peltier, and sipper systems	ISA-220 Transmittance and Reflectance Accessory, Peltier, and sipper systems	VeeMax Variable Specular Reflectance Accessory, Praying Mantis Diffuse Reflectance Accessory, Peltier, and sipper system
Mercury lamp accessory	✓	✓	✓
Compliance with Insight Pro Software			
Current Pharmacopoeias	USP and EP	USP and EP	USP, EP, and JP
21 CFR Part 11*	✓	✓	✓
Data storage	✓	✓	✓
Warranty	2 years	2 years	2 years

*Requires Insight Pro Security Software

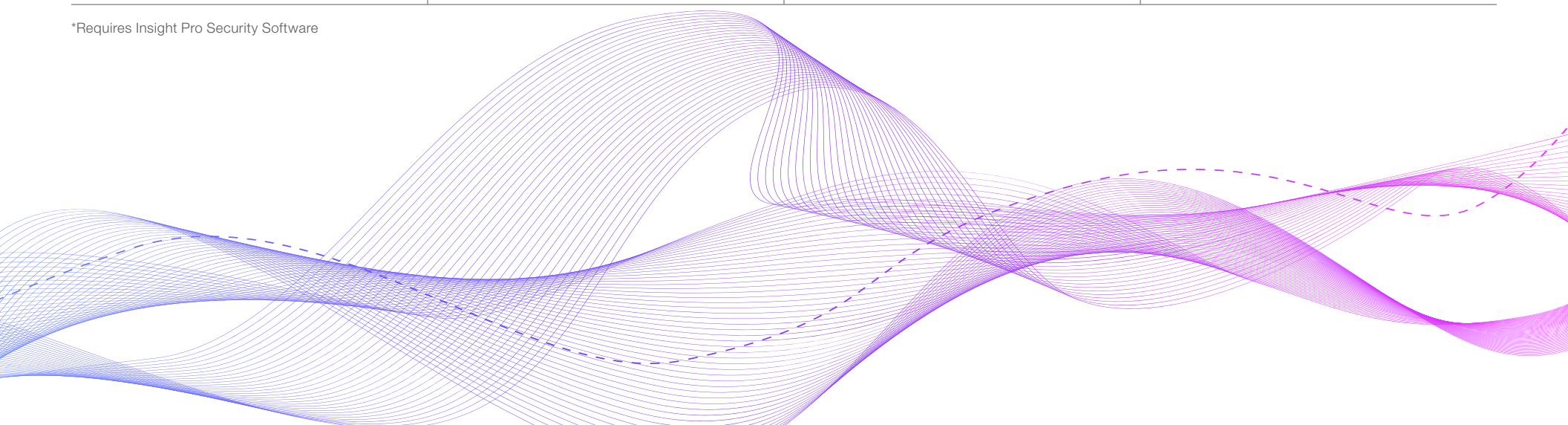

Cost-effective, reliable performance

Evolution Spectrophotometers incorporate a high-performance optical design, versatile Insight Pro Software packages, and the highest quality accessories for the most demanding applications.

Easy sample access

Quick-release sample compartment lid

Optimized cell positioning

Horizontal and vertical positioning adjustments to optimize energy throughput. A stable support system ensures accurate positioning of the cell in the beam every time.

Versatile sampling options

Large, room light resistant sample compartment provides maximum versatility and ease of use for your most challenging samples. Hose connectors, a pass-through slit for cables, and the option to remove the plate entirely to accommodate insulated tubes.

Long-term stability

Double-beam geometry is ideal for kinetics or any sample that might change over time during a measurement. Use the reference detector to monitor a control sample during data acquisition for greater stability of your long-term measurements.

Accurate rapid kinetics

Accurate kinetics measurements rely on precisely known zero-time data. Electronic in/out triggering provides the highest level of accuracy for rapid-mixing kinetics measurements.

Faster scanning

Scan samples up to 6,000 nm/min. A 31,000 nm/min slew speed makes both scanning and non-scanning measurements faster.

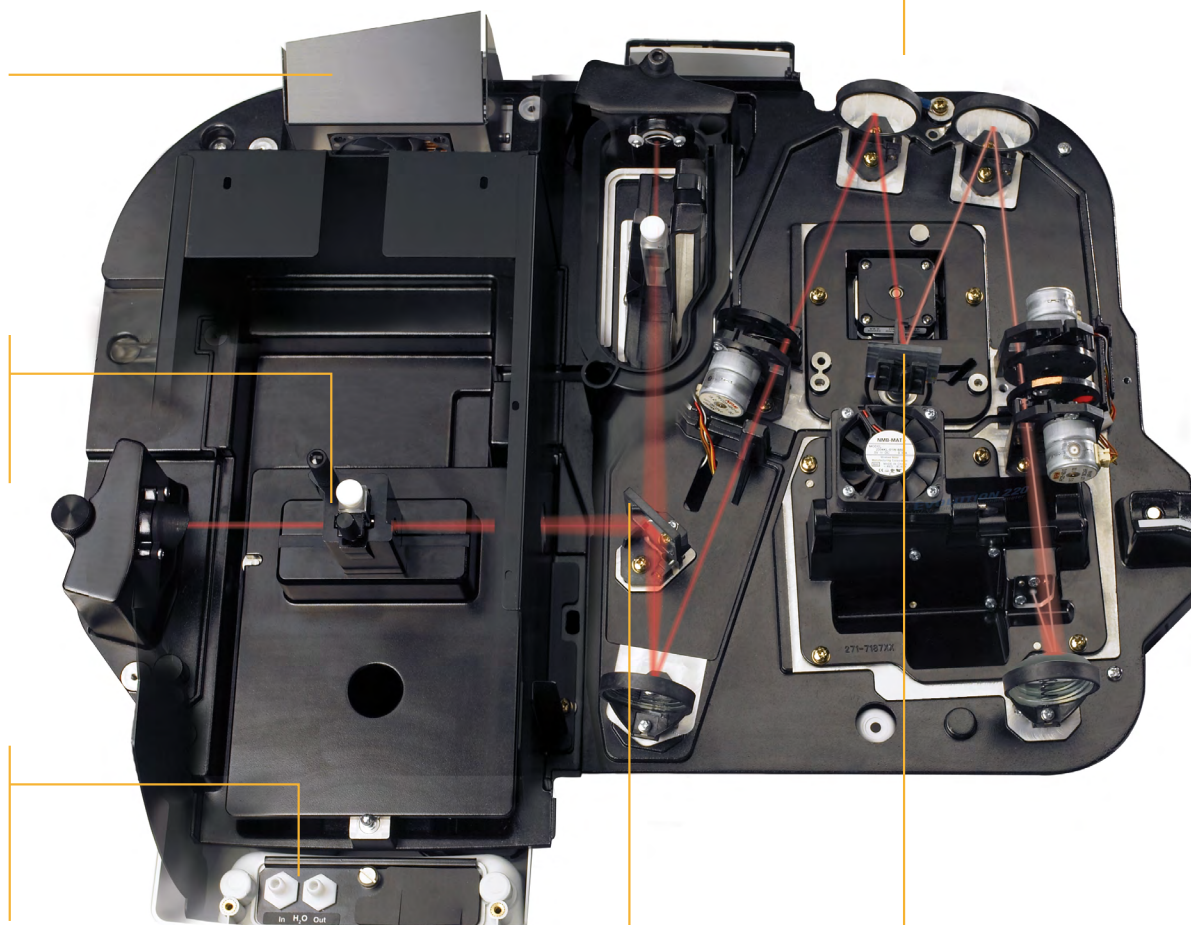

Optics

Quartz overcoated optics for long-lasting reflectivity and cleaning without damaging the optical surface

Mercury lamp option

Primary reference standard, allows seamless validation and calibration of the instrument

Light source

Xenon flash lamp is only on when taking measurements extending its lifetime

Slit mechanism

Photo-etched slits for greater accuracy. Stepper-motor driven slit drive with intelligent optimization.

Grating

1200 lines/mm, 240 nm blazed, holographic grating, for exceptional stray light performance

Micrometer monochromator

drive with sliding coupling provides excellent accuracy, reproducibility and minimizes temperature effects

Chassis

Rigid, cast-aluminum base with optical mounts bolted directly onto the base provides superior system stability and reliable results

Detectors

Silicon photodiodes for extended wavelength range to 1100 nm

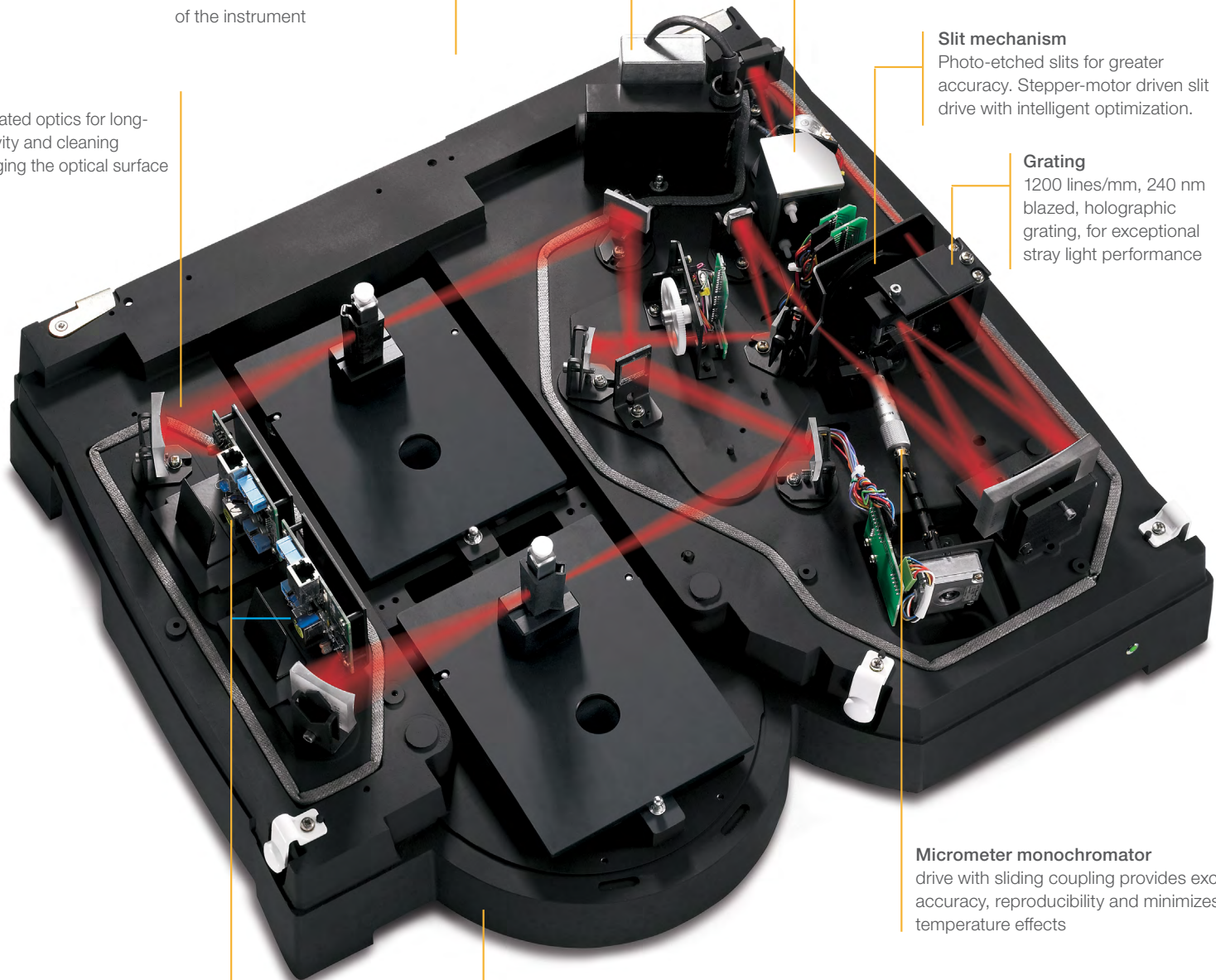

Evolution UV-Vis Spectrophotometers accessories for enhanced productivity*



Automated cell changers—ambient & thermostatted

- [7-cell rotary](#) and [8-cell linear](#)



[Scattering solids sample measurements](#)—diffuse transmittance and reflectance

- Integrating sphere for Evolution One Plus



1-cell sample holders—ambient & thermostatted

- Full range to accommodate most sampling vessels such as microcells, cuvettes, test tubes, vials, and more



[Solid sample measurement](#)—specular reflectance

- 8°, 15°, 20°, 30°, 45°, and 60° options
- VeeMax® variable angle 30° – 80° for Evolution Pro



Temperature monitoring

- [Peltier system](#), temperature probes, recirculators



[Solid sample measurement](#)—diffuse reflectance

- Praying Mantis for Evolution Pro



[Sipper systems](#)

- For sample delivery greater than 200 μ l



[Autosamplers](#)

- For high-volume sampling



[Fiber optics sampling](#)

- For analysis of sample outside of the sample compartment

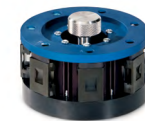

[Smart calibration validation carousel](#)

- Routine, time-saving performance validation

Specifications		Evolution One UV-Vis Spectrophotometer	Evolution One Plus UV-Visible	Evolution Pro UV-Visible
Optical design		Double-beam with sample and reference cuvette positions; Czerny-Turner monochromator	Double-beam with sample and reference cuvette positions; Application Focused Beam Geometry (AFBG); Czerny-Turner monochromator	Double beam with sample and reference cuvette/ accessory positions; Modified Ebert monochromator
Spectral bandwidth(s)		1.0 nm	Variable: 1.0 nm; 2.0 nm; AFBG Microcell optimized; AFBG Fiber optic optimized; AFBG Materials optimized	Selectable 0.5, 1.0, 1.5, 2.0, 4.0 nm
Light source		Xenon flash lamp Typical lifetime: >5 years; longer if not using live display Warranty period: 3-year source replacement warranty		Xenon flash lamp Typical lifetime: >5 years; longer if not using live display Warranty period: 3-year source replacement warranty
Detector		Dual Silicon Photodiodes		Detector dual-matched silicon photodiodes
Scan ordinate modes		Absorbance, % Transmittance, % Reflectance, Kubelka-Munk, log (1/R), log (Abs), Abs*Factor, Intensity		Absorbance, % Transmittance, % Reflectance, Kubelka-Munk, Log(1/R), Log(Abs), ABS × Factor, Intensity, 1st–4th Derivative
Grating		Holographic, 1200 lines/mm, blazed at 250 nm		Holographic, 1200 lines/mm, blazed at 240 nm
Beam Separation		N/A		210 mm
Wavelength	Range	190–1100 nm		190–1100 nm
	Accuracy	±0.5 nm (541.9 nm xenon, 546.1 nm mercury lines) ±0.8 nm (full range 190–1100 nm)		±0.20 nm (546.07 nm Hg emission line) ±0.30 nm (190–900 nm)
	Repeatability	≤0.05 nm (546.1 nm mercury line, SD of 10 measurements)		≤0.05 nm (546.1 nm mercury line, SD of 10 measurements)
	Scanning speed	<1 to 6000 nm/min; variable		Variable, up to 6000 nm/min
	Data intervals	10, 5, 2, 1.0, 0.5, 0.2, 0.1 nm		10, 5, 2, 1, 0.5, 0.2, 0.1, 0.05 nm
Photometric	Range	>3.5 A		>4 A
	Display Range	-0.3 to 4.0 A		±6 A
	Accuracy—Instrument*	1A: ±0.004 A 2A: ±0.008 A Measured at 440 nm using neutral density filters traceable to NIST		1A: ±0.004 A 2A: ±0.004 A 3A: ±0.006 A Measured at 440 nm using neutral density filters traceable to NIST
	Repeatability	1A: ±0.0002 A		1A: ±0.0001 A
	Noise	0A: ≤0.00015 A 1A: ≤0.00025 A 2A: ≤0.00050 A 260 nm, 1.0 nm SBW, RMS		0A: <0.00018 A 1A: <0.00022 A 2A: <0.00050 A 500 nm, 2.0 nm SBW, RMS
	Drift (Stability)	<0.0005 A/hour 500 nm, 1.0 nm SBW, 1 hour warm-up		<0.0005 A/hour 500 nm, 2.0 nm SBW, 2 hour warm-up
	Stray Light	KCl, 198 nm: ≤1% T NaI, 220 nm: ≤0.05% T NaNO ₂ , 340 nm: <0.05% T		KCl, 198 nm: ≤0.4% T NaI, 220 nm: ≤0.032% T NaNO ₂ , 340 nm: <0.01% T
Baseline flatness		±0.001 A (200–800 nm) 1.0 nm SBW, smoothed		±0.001 A (200–800 nm) 2.0 nm SBW, smoothed
Dimensions (W × D × H)		593 × 475 × 266 mm (23.3" × 18.7" × 10.6")		609 × 526 × 270 mm (23.9" × 20.7" × 10.6")
Weight		14.5 kg (32 lb)		20 kg (44 lb)
Electrical supply		100–240 V, 50–60 Hz, selected automatically 150 W maximum		100–240 V, 50–60 Hz

*When testing instrument performance, the specification used for pass/fail determination is the sum of the instrument specification listed here and the uncertainty in the calibration data for the filter, listed on the calibration certificate.



Laboratory solutions backed by worldwide service and support

Tap into our expertise throughout the life of your instrument. Thermo Fisher Scientific offers professional support through our worldwide network of highly trained and certified engineers. In many nations, [Unity™ Lab Services](#), part of Thermo Fisher Scientific, offers direct support. Elsewhere, our distribution partners' engineers receive the same factory training as our Unity engineers and stand ready to provide you with the same high level of service and support. Put our experts to work for you to provide the services you need from system installation and training to technical support. Ask your Thermo Scientific sales representative about available product support services designed to keep your instrument in peak operating condition.

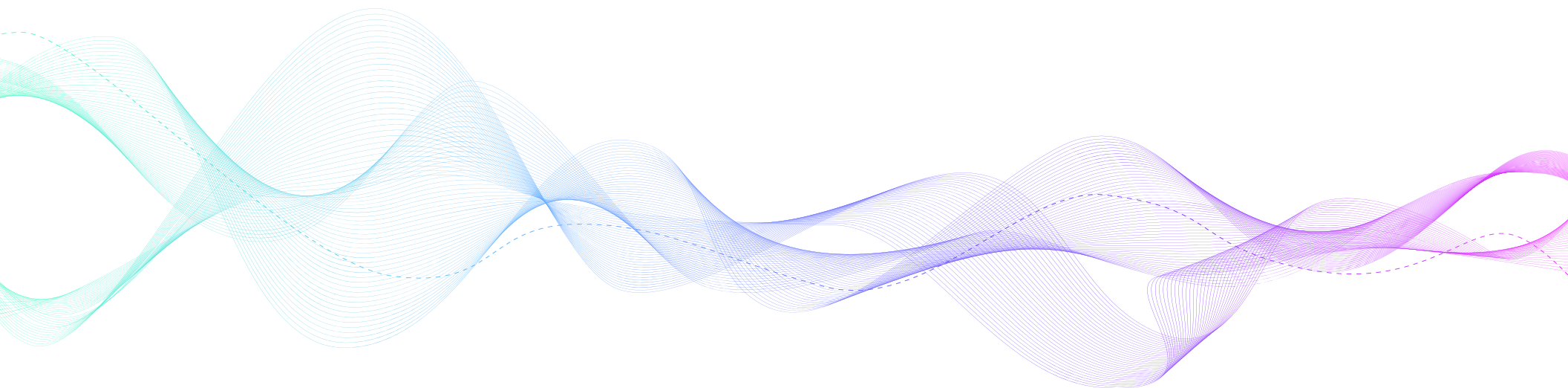

Find out more at thermofisher.com/evolution

ThermoFisher
SCIENTIFIC

For research use only. Not for use in diagnostic procedures. For current certifications, visit thermofisher.com/certifications.

© 2021 Thermo Fisher Scientific Inc. All rights reserved. All trademarks are the property of Thermo Fisher Scientific and its subsidiaries unless otherwise specified. **BR53458 1021 M**