

From Eye to Insight



ARveo 8

The infinite possibilities of digital neurosurgery start here



ARveo 8, the digital visualization microscope for neurosurgery from Leica Microsystems, evolves with you into the digital future enabling your entire neurosurgical team to benefit from a new level of enhanced AR visualization, efficiency and accessibility for more informed and precise neurosurgeries. ARveo 8 unlocks the door to the digital future.

The possibilities are infinite.





Enhanced visualization for greater precision

GLOW AR technology and GLOW800 AR fluorescence

Pages 4-5



Enhanced efficiency across the entire team

ARveo 8 graphical user interface, visualization in the OR and beyond with HD 3D viewing and recording

Pages 6-7



Enhanced to unlock the digital future

EnhancePath, image guided surgery, robotics integration, endoscope compatibility

Pages 8-9



Enhanced ergonomics make workflows flow

ARveo 8 design for comfortable working postures and smooth workflows

Pages 10-11

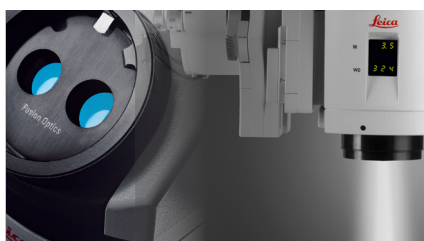

Enhanced optical image quality

FusionOptics and innovative illumination

Enhancing patient safety

Optimal illumination and fall-back technology

Pages 12-13

Enhanced visualization for greater precision

ARveo 8 enhances visualization. With its ultra-fast processing, latency is reduced by 44%—synchronizing the visual and tactile faster for more precise surgeries.¹ The integration of world-renown Leica optics into the GLOW AR ecosystem is at the heart of the ARveo 8 visualization capabilities. They help you obtain more information, so that you can, e.g., safely navigate a complex tangle of abnormal arteries and veins and preserve key nerves and vessels.

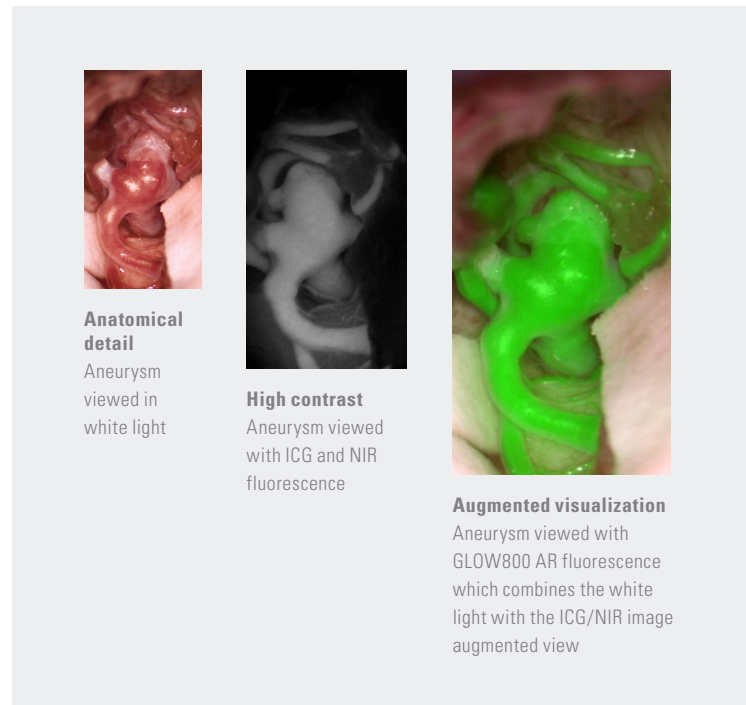

Groundbreaking GLOW AR technology captures, optimizes, and combines different sources of information such as multiple spectral bands of visible and fluorescent light. The result is a fully synchronized, real-time, augmented view of the surgical field.

“Suddenly we had the blood vessels lighting up, but we would still see the brain structure around them. That was an aha effect: We suddenly could see more. We really got closer to what we think is augmented reality.”

Professor Raphael Guzman MD, Professor of Neurosurgery, Vice Chairman of the Department of Neurosurgery, University Hospital and University Children’s Hospital, Basel, Switzerland, about his experiences when he first used GLOW800.

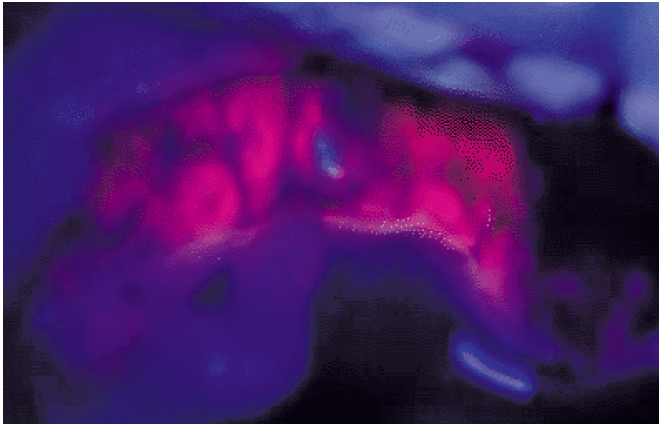

FL400 oncological fluorescence

The fluorescence module FL400 is used during open neurosurgery in conjunction with the active substance 5 aminolevulinic acid (5-ALA). It supports resection by allowing differentiation of tumor tissue from healthy brain tissue.²

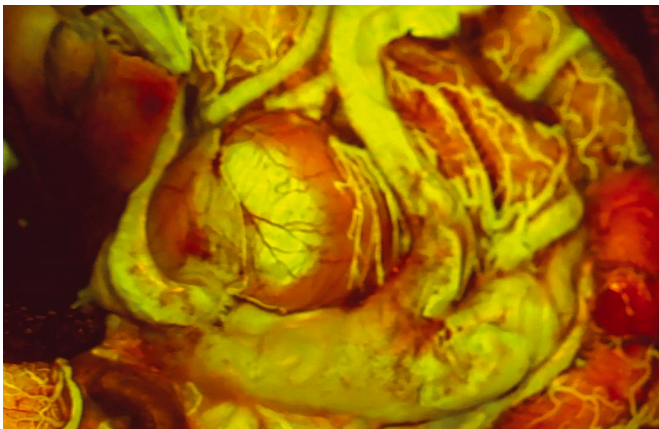

FL560 fluorescence

FL560 allows observation of fluorophores with an excitation range between ~460 nm and ~500 nm. It allows you to view non-fluorescent tissue in natural color and simultaneously observe fluorescence in a bright yellowish-green color.



GLOW800 AR fluorescence

GLOW800 augmented reality fluorescence takes the high contrast of NIR imaging with ICG and combines it with white light. The result is a single view of natural-colored anatomy, augmented by real-time vascular flow.

Enhanced efficiency across the entire team



ARveo 8 enhances efficiency. When every second counts in a surgery, anything that slows it down is a barrier to the best possible outcome. ARveo 8 supports a more collaborative workflow for the entire surgical team. Its new GUI strips away interface complexity, keeping only what's essential for a logically clear path to easy setup and immediate adjustments, at any given point in time. Its 4K external display and multiple display modalities give the full team a better picture and aid in teaching and patient documentation.

Right before your eyes

With CaptiView image injection, you and your assistant can keep all eyes on the surgical site and fully focus on the procedure.

- > Looking up to reconcile the fluorescence image with the white light image by comparing them from the monitor and through the oculars is a thing of the past, thus enhancing workflow efficiency and patient safety
- > View data as an overlay on the live surgical image or as non-correlated in left, right, or both oculars
- > Rely on full-HD 1080p resolution and 500:1 contrast for brilliant images
- > View GLOW AR fluorescence, IGS data from systems of leading manufacturers, microscope information, endoscope imaging feeds, and additional input streams thanks to the OpenArchitecture design

One 3D view for the entire team

Exoscopic visualization during surgery provides the same image to the entire OR team, thus enhancing collaboration and workflow efficiency. Heads-up, you work with the full depth perception and high resolution you require, but do not use the oculars.

- > Visualize minute anatomical details with natural color differentiation on a much larger scale on the 31-inch microscope screen or on the 55-inch 4K cart-mounted 3D monitor
- > Position optics carrier and cart-mounted 3D monitor exactly where you need them, then work in an upright posture. This reduces physical strain on your back, neck, and spine and can help avoid musculoskeletal pain

- > Put the optics carrier in positions that give you additional insight but would be impossible to achieve if you needed to look through the oculars
- > Take teaching to the next level, with everyone able to follow surgeries magnified on a large 4K 3D monitor
- > Support OR workflow; the shared 3D view enables your OR team to follow your every delicate move and be ready for the next step, even in complex cases

The ARveo 8 is a hybrid system.

During a 3D heads-up surgery, you can return to the eyepieces at any time and continue working there.





Optional 55-inch 4K 3D cart-mounted monitor³ for flexible positioning



31-inch 4K 3D monitor³

2-in-1 image display system: The monitor can show the graphical user interface as well as the microscope image

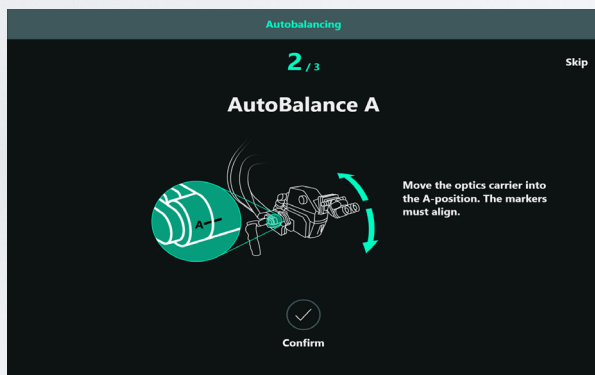

Intuitive graphical user interface

The ARveo 8 graphical user interface is designed to be self-explanatory for all members of the OR team.

- > Assign different roles with different levels of user rights
- > Be sure user settings cannot accidentally be changed thanks to password protection
- > Be confident patient and user data are secure thanks to increased cybersecurity
- > Operate the microscope easily thanks to intuitive illustrated navigation, which, e.g., allows to program handgrip functions easily
- > Use the capacitive display not only for microscope setting, but also as an additional monitor

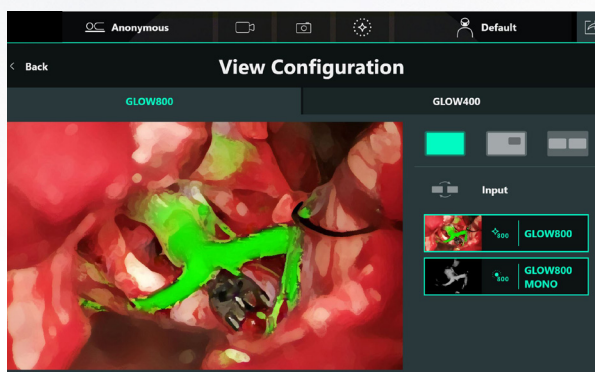

Ready to capture and save

Combined with its high-performing hardware, stress-tested software stability, and robust cyber security the new integrated Leica camera and recording system enables:

- > Recording of video and still images to USB for transfer to your hospital network
- > Fast image storage and export of images
- > Media storage on 2 TB large storage space
- > Optimized data processing and connectivity for PACS and DICOM

Enhanced to unlock the digital future



ARveo 8 is ready to fulfill future needs. You can add new technologies as well as AR applications that will impact you, your entire surgical team, and your patients. We call this concept **EnhancePath**, our promise that ARveo 8 evolves with you into the digital future.

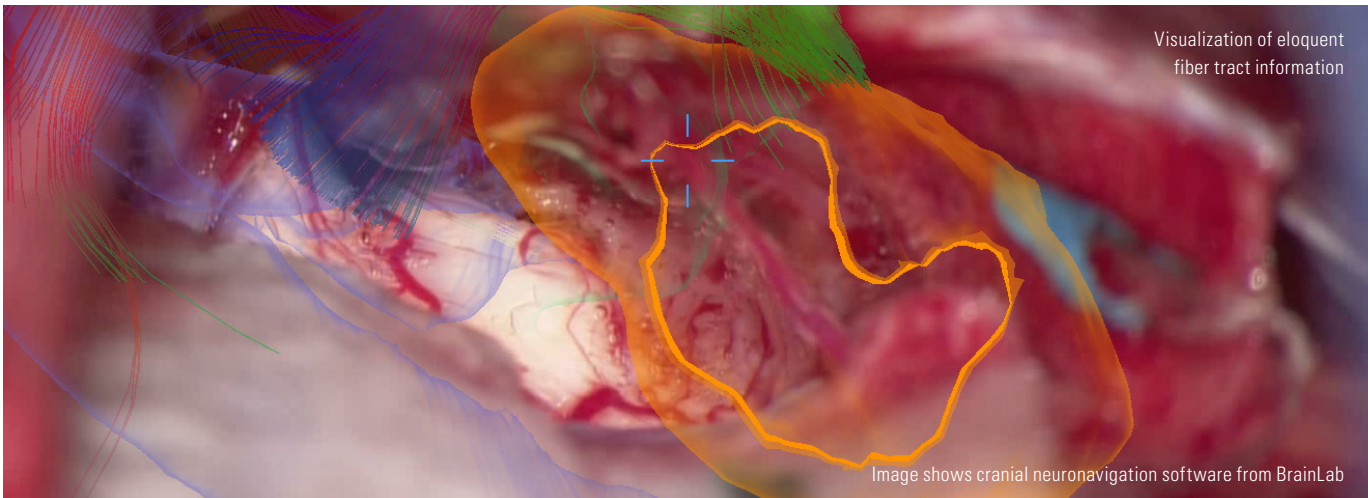

The ability to combine preoperative images with intraoperative imaging can be decisive during procedures. With ARveo 8 you can use image guided surgery systems to overlay your microscope view with additional imaging information, complement it with endoscope imaging as well as use robotic control to keep a specific point of interest in focus.

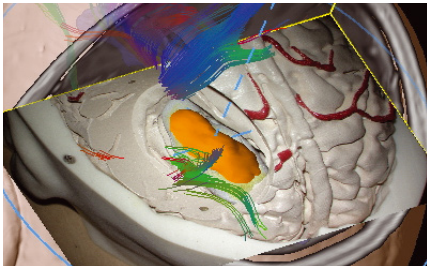

Align and view with ease

Support your intraoperative assessment with flexible viewing and registration.

- > Update image realignment during surgery using the microscope image
- > View information more ergonomically with picture-in-picture navigation options
- > Get support when assessing critical areas due to visualization of planned structures as semi-transparent volumes combined with a virtual 360-degree target view

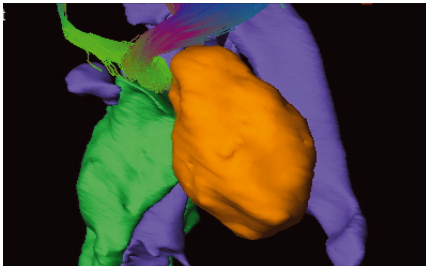

Navigation-controlled robotics

ARveo 8 enables robotic alignment of the microscope via the Brainlab IGS system.

- > Keep your image in focus during the entire neurosurgery, thanks to the tip focus function of the latest cranial navigation software from BrainLab
- > Rest assured that you always have a centered view in spite of microscope movement thanks to “follow tip” or “move to pin” functions



Technical compatibility with KARL STORZ® video systems⁴

Supplement your ARveo 8 microscope with a video system feed from an endoscope. You can display the video directly in the eyepieces or on the microscope’s monitor. Switch seamlessly with just a touch of the microscope handle from the microscope image to an endoscopic image feed and back—your workflow will not be interrupted.

⁴ Please contact your local sales representative for more information

Enhanced ergonomics make workflows flow



Long overhead reach
for flexible positioning
in your OR



More space
to work
(600 mm)

With ergonomics and efficiency factored into every design decision, from software to switch, you can experience all the benefits of augmented reality-enhanced surgery, without interrupting workflow.

ARveo 8 adapts easily to your body frame and your preferred style of working

- > Choose from a range of binoculars with full 360°-rotation for main surgeon and assistant to accommodate different operating positions and body frames
- > Achieve a comfortable upright working posture for both main and opposite assistant thanks to the design of the optics carrier
- > Maneuver the surgical site easily thanks to 600 mm working distance. Giving you more space to work, passing long instruments often used in spine procedures becomes effortless
- > Limit potential strain of harsh movements thanks to the lightweight handling and extensive range of movement of the optics carrier



Full control

With ARveo 8, you can control digital AR technologies and recording systems via handle or the wireless footswitch, enabling you to work without interruptions.

Large overhead clearance



Made to withstand

The premium overhead stand from our partner Mitaka was designed and built for intensive, flexible, and extremely reliable performance in the OR. Based on aerospace technology, it has a robust, full-metal construction with long reach and a space-saving compact footprint.

Effortless operation via handle or wireless footswitch

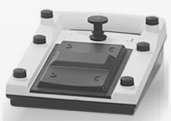

Compact footprint frees up OR space



Smooth balancing

Save time by pushing a button once for AutoBalancing or twice to balance all six axes. To rebalance the system intraoperatively, even through a sterile drape, simply push the AC/BC button located above the optics carrier.

Comfortable air removal

Drape your ARveo 8 with a surgical microscope drape, activate the drape air removal system with one touch, and start working.

Easy maneuvering

Adjust ARveo 8 to different procedures and surgery steps thanks to its extensive range of movement and tilt of the optics carrier, combined with long overhead reach and fast stabilization.

Enhanced optical image quality

Enjoy the best of two worlds for a significantly expanded area in full focus and less refocusing.



FusionOptics Technology

1. Two separate optical paths
2. One path provides great depth of field
3. The other path provides high resolution
4. The brain effortlessly merges the images into a single, optimal spatial view

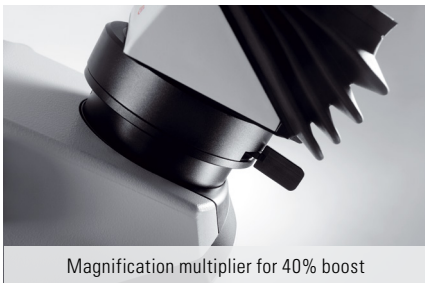

Magnification multiplier for 40% boost



SpeedSpot for fast focusing



Fine focus for rear assistant

For too long, surgeons had to compromise between high resolution and greater depth of field – no more! FusionOptics generates two separate beam paths that carry separate visual information. Your brain then effortlessly merges this into a single, optimal spatial image. The result? A more complete view of the surgical field thanks to a significantly expanded area in full focus. And what's more, less refocusing helps streamline your workflow.

Everything is illuminated

The more you know, the more empowered you become to make the right decisions for your patients. Small Angle Illumination (SAI) combined with bright 400 W Xenon illumination allows light to penetrate to the bottom of deep, narrow cavities.

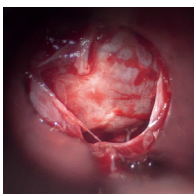

Without SAI
(400 mm working distance)

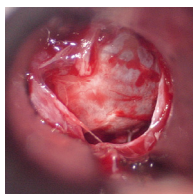

With SAI
(400 mm working distance)

Visualization that adapts to you

- > The optional magnification multiplier boosts magnification by 40%
- > SpeedSpot uses two laser beams acting as a focusing reference to quickly provide a defined focus point for all viewing positions (surgeon, assistant, and camera)
- > Your rear assistant has an independent fine focus
- > A range of binoculars are available, all adjustable to different heights and positioning due to full 360°-rotation



Enhanced patient safety

ARveo 8 has been designed for reliable operation and safer light levels, enhancing patient safety as well as minimizing the risk of interruption.



Intuitive touch-screen



Bright light only where you need it



Keep working uninterrupted

Optimal, consistent light intensity

Be confident that you have maximum brightness while protecting patient tissue.

- > BrightCare Plus automatically adapts light intensity to the working distance, providing safer illumination with up to 60% reduction of light intensity
- > An internal luxmeter provides real-time light data, measuring light intensity from actual bulb output instead of via an algorithm or formula
- > See what you need to see, even at lower light levels, thanks to extremely efficient light transmission

Optimal field of illumination

Illuminate only what you need to see with intelligent, responsive light adjustment.

- > Autolris automatically adjusts the diaphragm in line with the zoom. As the field of view decreases, so does the field of illumination, ensuring that only the visible area is illuminated
- > The lack of peripheral illumination means there is no risk that tissue outside the field of view could be harmed by light exposure

Stay operational

Continue your surgery uninterrupted in the rare case of a technical problem.

- > Two 400-Watt xenon arc-lamp illumination systems with independent lamps and boards ensure that if a bulb fails, the second system will automatically be activated
- > The microscope and the video recording system are fully independent. Should a video system error occur, ARveo 8 will retain full functionality

Technical specifications

OPTICS AND ILLUMINATION

FusionOptics	For increased depth of field and high resolution for main surgeon
Magnification	6:1 zoom, motorized optional magnification multiplier
Objective / working distance	225–600 mm, motorized multifocal lens, continuously adjustable with manual adjustment option
Eyepieces	Wide-field eyepieces for persons wearing glasses
Observation	Full stereo view for main surgeon and opposite assistant, semi stereo view for two side assistants
Integrated 360° rotatable adapter	For main surgeon and opposite assistant binoculars
SpeedSpot	Laser focusing aid for fast and exact positioning of the microscope
Illumination	<ul style="list-style-type: none"> - High-output 2x 400-W redundant xenon arc-lamp systems via fiber optics cable - Continuously variable illumination field diameter - Continuously adjustable brightness at constant color temperature - Automatic activation of second illumination
Autolris	Built-in automatic, zoom-synchronized illumination field diameter, with manual override and reset feature
BrightCare Plus	Safety function through working distance-dependent limitation of the brightness, controlled by built-in luxmeter

MANEUVERABILITY AND CONTROL

Robotic function	<ul style="list-style-type: none"> - Motorized XY movement - Externally controllable (optional)
Control	- Programmable handles
Balancing	<ul style="list-style-type: none"> - Automatic balancing of stand and optics - Automatic intraoperative balancing - Manual fine balancing
Microscope carrier	“Advanced Movement” system for balancing six axes and vibration damping technology
Carrier for monitor	Flexible arm with four axis for rotation and inclination

MODULAR OPTIONS

GLOW800 augmented reality fluorescence	<ul style="list-style-type: none"> - Fluorescence excitation 790 nm - Fluorescence signal 835 nm - Image sensor 1x 1/1.2” - Dedicated high-sensitivity HD IR video camera
FL400 fluorescence	FL400 blue light fluorescence module
FL560 fluorescence	FL560 fluorescence module
CaptiView image injection	Full-HD image injection module
2D/3D video options	<ul style="list-style-type: none"> - 2D HD 27-inch monitor - 4K 3D 31-inch monitor on microscope - 4K 3D optional 55-inch monitor cart system - Video fine focus - Integrated auto focus - 3 surgeon-controlled digital zoom levels - integrated 4K upscaling software
Leica Recording System	<ul style="list-style-type: none"> - Fully integrated 2D and/or 3D recording - DICOM/PACS integration
Universal drape air removal with SMARS ⁴	<ul style="list-style-type: none"> - One-button drape air removal system - Compatible with surgical microscope drapes
Additional controls	<ul style="list-style-type: none"> - Mouthswitch to activate multi-directional movement - 12-function wireless footswitch
OpenArchitecture ⁴	- Easy integration of IGS systems and other inputs
Cyber Security	<ul style="list-style-type: none"> - MDS2 Medical Device Security - comply with international standard such as ANSI/UL

TECHNICAL DATA

Power connection	<ul style="list-style-type: none"> - 1300 VA 50/60 Hz - 100 V - 240 V / 50 - 60 Hz
Protection class	- Class 1
Materials	- Entire solid metal construction coated with a paint which is designed to provide an antimicrobial effect on surfaces
Load	<ul style="list-style-type: none"> - Swing arm: min. 6.7 kg, max. 12.2 kg from microscope dovetail ring interface - Monitor arm: max. 16kg
Weight	- Approx. 320 kg without load

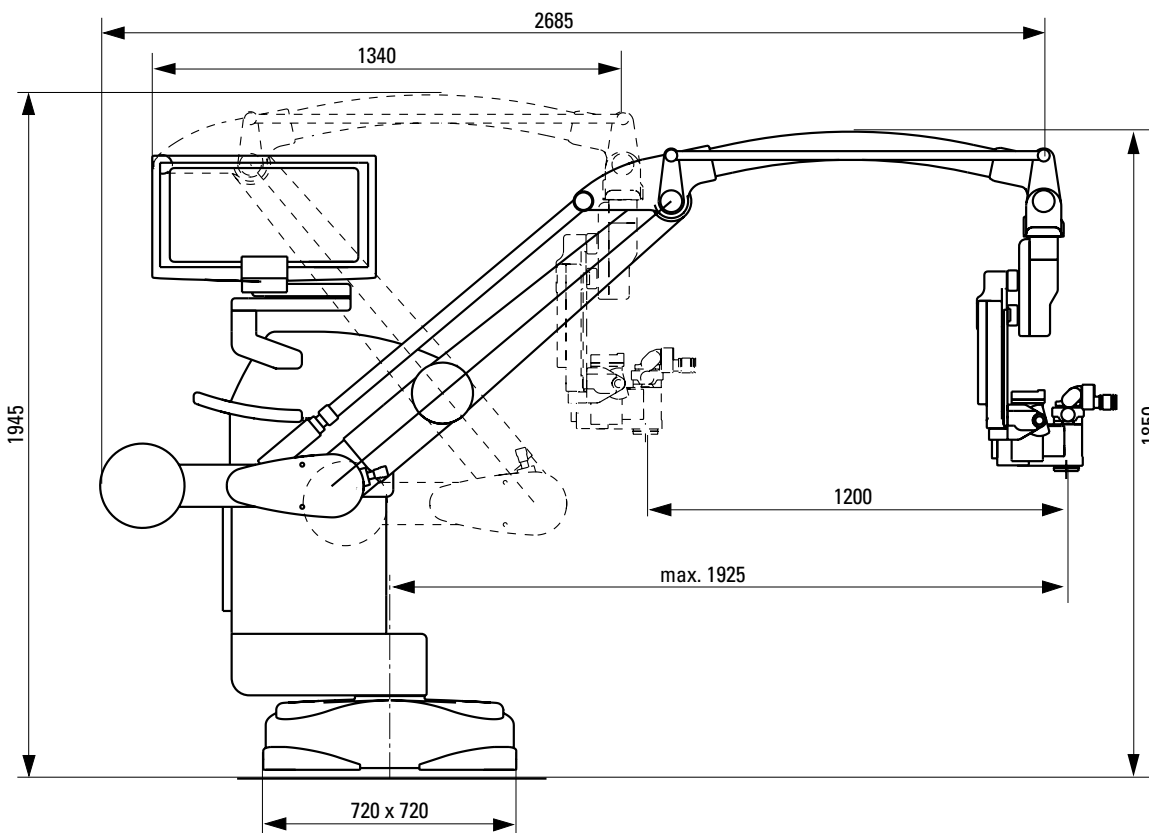
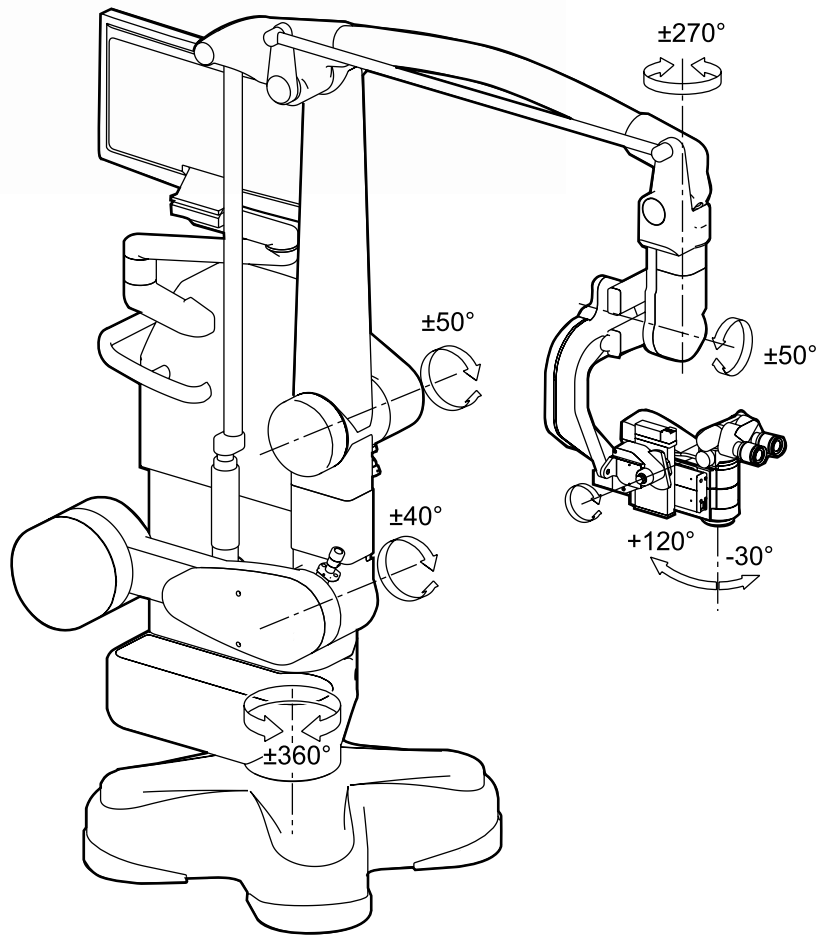



Leica Microsystems (Schweiz) AG
Max Schmidheiny-Strasse 201
9435 Heerbrugg, Switzerland



Class IIa GLOW800

Class I surgical microscope ARveo 8 incl. accessories

Not all products or services are approved or offered in every market and approved labeling and instructions may vary between countries.
Please contact your local Leica representative for details.



CONNECT
WITH US!



Leica Microsystems (Schweiz) AG · Max Schmidheiny Strasse 201 · CH-9435 Heerbrugg

T +41 71 726 3333 · F +41 71 726 3399

www.leica-microsystems.com